



Datasheet

Part No:
PA.11

Description:

2.4GHz Band Dielectric Ceramic PIFA
SMT Antenna for Bluetooth/WLAN/ZigBee Applications

Features:

2400-2484Mhz, 1.5dBi Peak Gain
Size: 10mm*4mm*3mm
Designed for the top right hand corner edge of the Component side of the board (bottom left corner edge)
SMT Mount
RoHS Compliant

1. Introduction	3
2. Specifications	4
3. S11 Response Curve	5
4. Test Position	6
5. Summary of Test Results	7
6. Antenna Pattern	8
7. Mechanical Drawing	13
8. Recommended Footprint for Evaluation Board	14
9. Packaging	15
10. Recommended Reflow Temperature Profile	17
<hr/>	
Changelog	18

Taoglas makes no warranties based on the accuracy or completeness of the contents of this document and reserves the right to make changes to specifications and product descriptions at any time without notice. Taoglas reserves all rights to this document and the information contained herein. Reproduction, use or disclosure to third parties without express permission is strictly prohibited.



1. Introduction



This specification covers the Dielectric PIFA Antenna for 2400-2484MHz, covering such applications as Wi-Fi, Bluetooth and Zigbee. A ceramic dielectric

PIFA antenna offers smallest footprint, superior gain characteristics and improved isolation over traditional PCB based antennas. This antenna has been developed for the top right hand corner edge of the component side of the Board (bottom left corner edge), the antenna has to be positioned on a non-ground (copper/metal free) area with the feed-point matched direct to the module. Please refer to Recommended Foot print Diagram (8.0 Page 14).

Many module manufacturers specify peak gain limits for any antennas that are to be connected to that module. Those peak gain limits are based on free-space conditions. In practice, the peak gain of an antenna tested in free-space can degrade by at least 1 or 2dBi when put inside a device. So ideally you should go for a slightly higher peak gain antenna than mentioned on the module specification to compensate for this effect, giving you better performance.

Upon testing of any of our antennas with your device and a selection of appropriate layout, integration technique, or cable, Taoglas can make sure any of our antennas' peak gain will be below the peak gain limits. Taoglas can then issue a specification and/or report for the selected antenna in your device that will clearly show it complying with the peak gain limits, so you can be assured you are meeting regulatory requirements for that module.

For example, a module manufacturer may state that the antenna must have less than 2dBi peak gain, but you don't need to select an embedded antenna that has a peak gain of less than 2dBi in free-space. This will give you a less optimized solution. It is better to go for a slightly higher free-space peak gain of 3dBi or more if available. Once that antenna gets integrated into your device, performance will degrade below this 2dBi peak gain due to the effects of GND plane, surrounding components, and device housing. If you want to be absolutely sure, contact Taoglas and we will test. Choosing a Taoglas antenna with a higher peak gain than what is specified by the module manufacturer and enlisting our help will ensure you are getting the best performance possible without exceeding the peak gain limits.

2. Specifications

The antenna has the electrical characteristics given in Table 1 under the Taoglas standard installation conditions as shown in the Evaluation Board figure.

Electrical	
Working Frequency	2400MHz ~ 2484MHz
Peak Gain	1.5dBi max
Polarization	Linear
Impedance	50 Ω
VSWR	2.0 max
Mechanical	
Dimensions	10*4*3mm
Termination	Ag (Environmentally Friendly Lead-Free)
Environmental	
Operating Temperature	-40~+85°C
Moisture Sensitivity Level (MSL)	3 (168 Hours)

* Data is measured on Taoglas Standard Reference PCB

3. S11 Response Curve

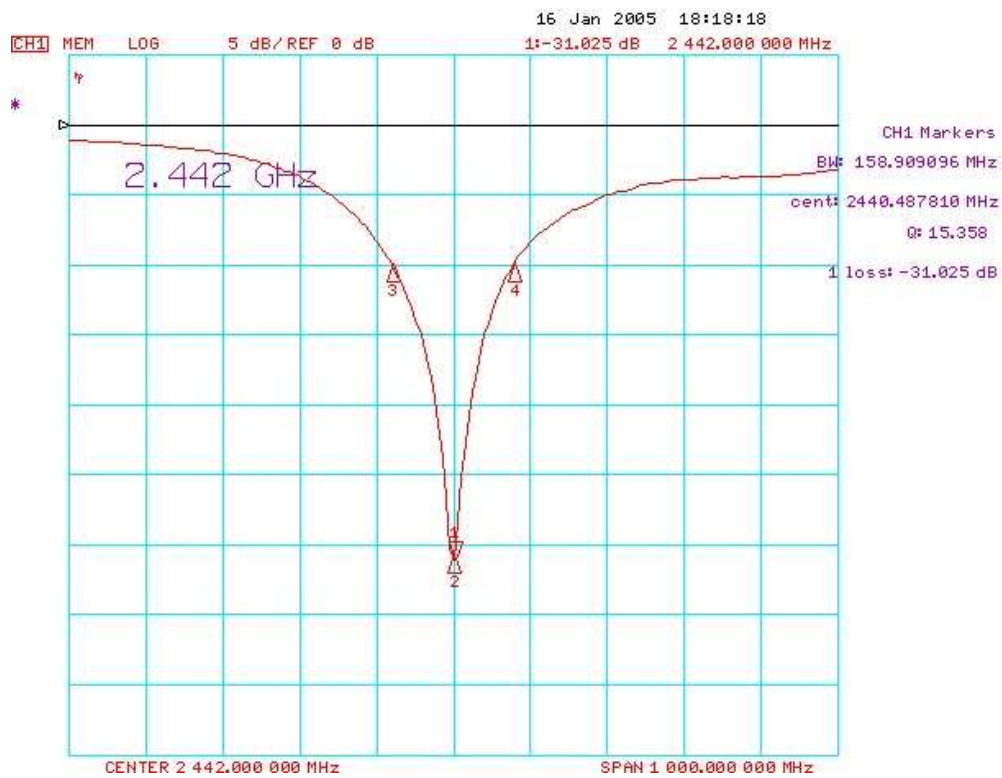

- * Gain is measured on test PCB
- * Ant position: Right side, top corner edge, horizontal

4. Test Position

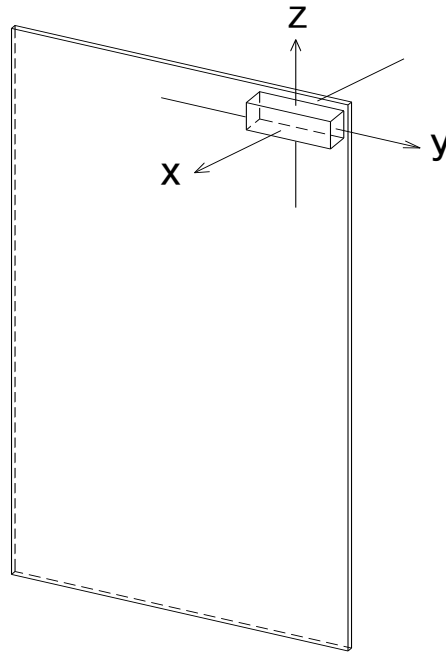

5. Summary of Test Results

5.1 Gain and Efficiency

Frequency (GHz)	Peak Gain(dBi)	Efficiency (%)
2.400	2.78	80.64
2.442	3.12	85.65
2.450	3.27	86.50
2.4835	2.76	75.91
2.500	2.34	68.07

5.2 Power Average Gain

Frequency (GHz)	Plane	Average Gain (dB)
2.4000	XY Plane	-1.622
	YZ Plane	-1.324
	XZ Plane	-0.561
2.4420	XY Plane	-2.464
	YZ Plane	-0.859
	XZ Plane	-0.312
2.4500	XY Plane	-1.424
	YZ Plane	-0.950
	XZ Plane	-0.224
2.4835	XY Plane	-2.949
	YZ Plane	-1.548
	XZ Plane	-0.784
2.5000	XY Plane	-2.444
	YZ Plane	-2.084
	XZ Plane	-1.258

6. Antenna Pattern – Wi-Fi and Bluetooth

6.1 Frequency: 2.400GHz

Far-field Power Distribution on X-Z Plane(E-Plane of L3 Pol Sense)
Gain=2.78 dBi; Total Radiating Efficiency: 80.64% @2.40000 GHz

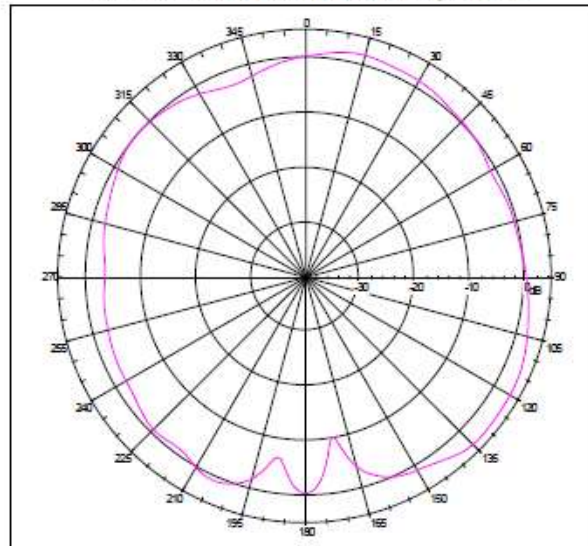

Far-field Power Distribution on Y-Z Plane(H-Plane of L3 Pol Sense)
Gain=2.78 dBi; Total Radiating Efficiency: 80.64% @2.40000 GHz

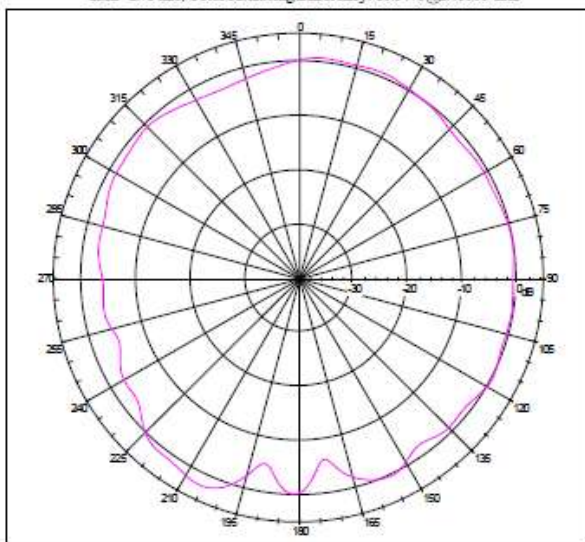

Far-field Power Distribution on X-Y Plane
Gain=2.78 dBi; Total Radiating Efficiency: 80.64% @2.40000 GHz

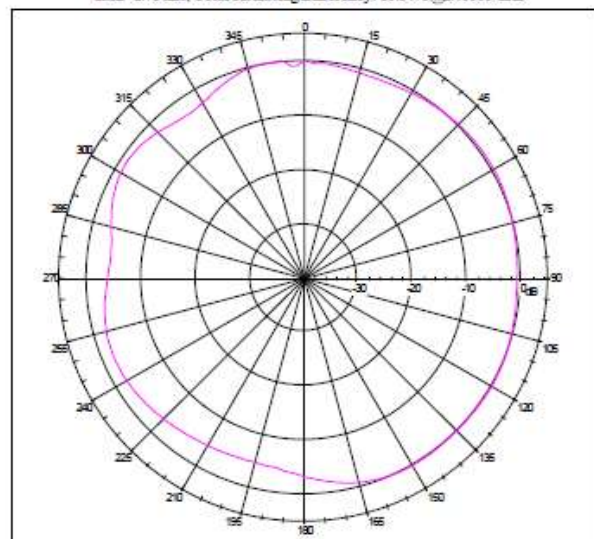

6.2 Frequency: 2.442GHz

Far-field Power Distribution on X-Z Plane(E-Plane of L3 Pol Sense)
 Gain=3.12 dBi; Total Radiating Efficiency: 85.65% @2.44200 GHz

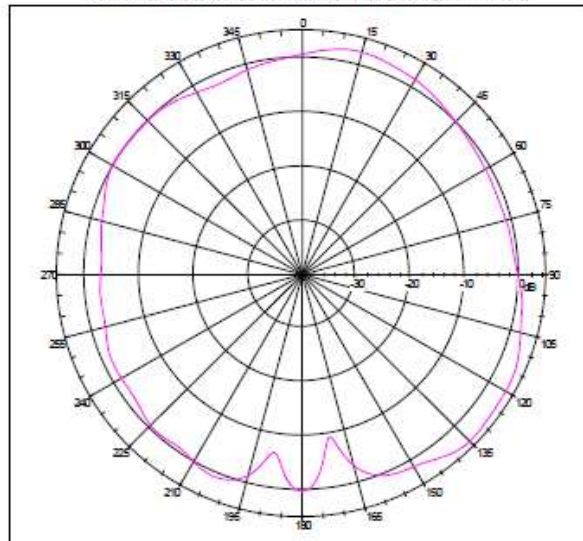

Far-field Power Distribution on Y-Z Plane(H-Plane of L3 Pol Sense)
 Gain=3.12 dBi; Total Radiating Efficiency: 85.65% @2.44200 GHz

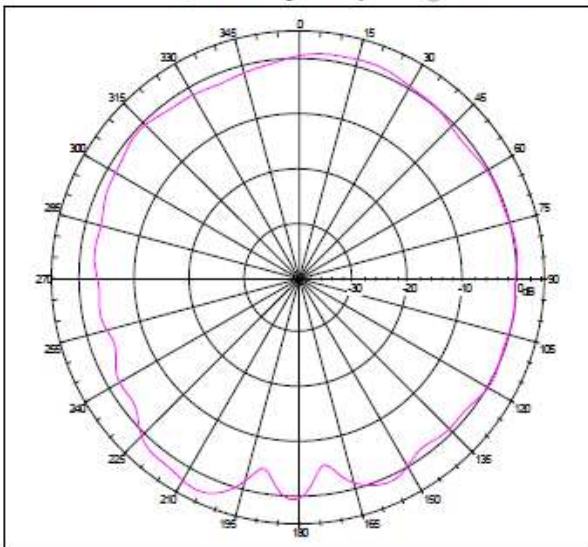

Far-field Power Distribution on X-Y Plane
 Gain=3.12 dBi; Total Radiating Efficiency: 85.65% @2.44200 GHz

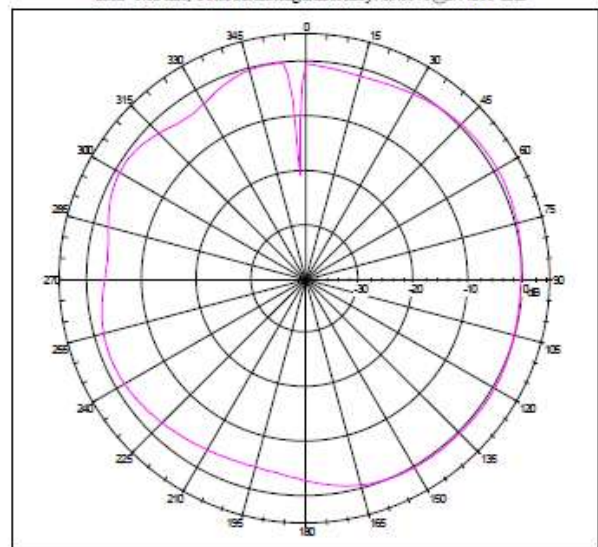

6.3 Frequency: 2.450GHz

Far-field Power Distribution on X-Z Plane(E-Plane of L3 Pol Sense)
Gain=3.27 dBi; Total Radiating Efficiency: 86.20% @2.45000 GHz

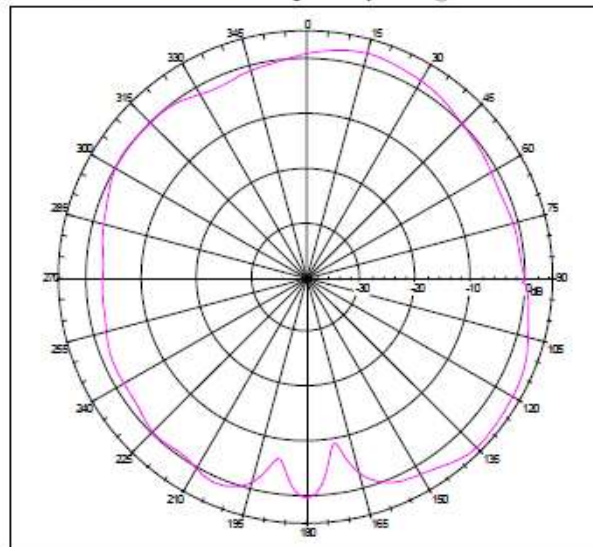

Far-field Power Distribution on Y-Z Plane(H-Plane of L3 Pol Sense)
Gain=3.27 dBi; Total Radiating Efficiency: 86.20% @2.45000 GHz

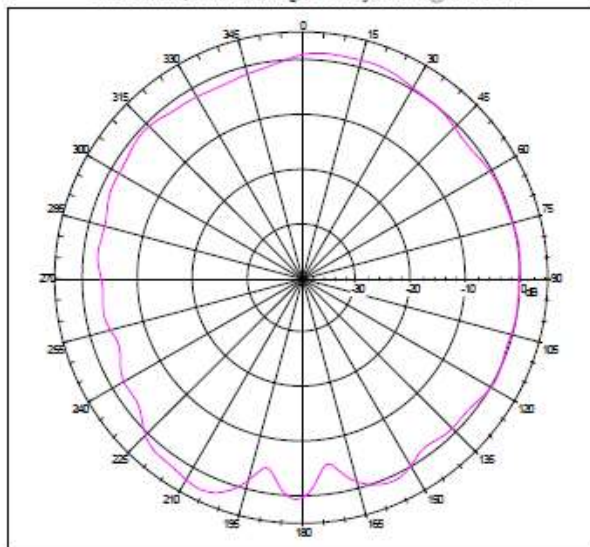

Far-field Power Distribution on X-Y Plane
Gain=3.27 dBi; Total Radiating Efficiency: 86.20% @2.45000 GHz

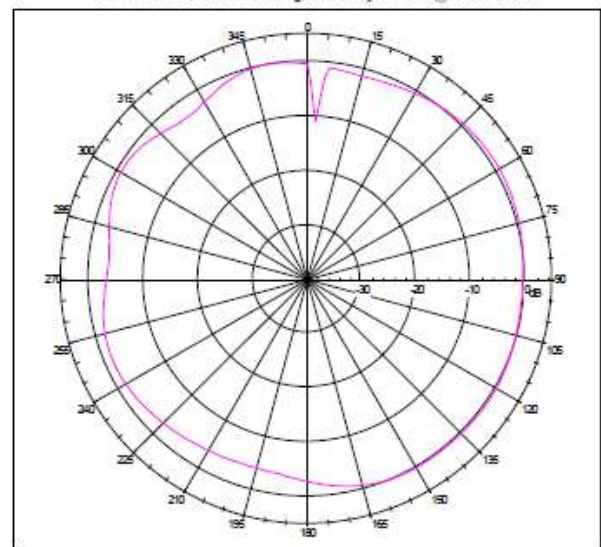

6.4 Frequency: 2.4835GHz

Far-field Power Distribution on X-Z Plane(E-Plane of L3 Pol Sense)
Gain=2.76 dBi; Total Radiating Efficiency: 75.91% @2.48350 GHz

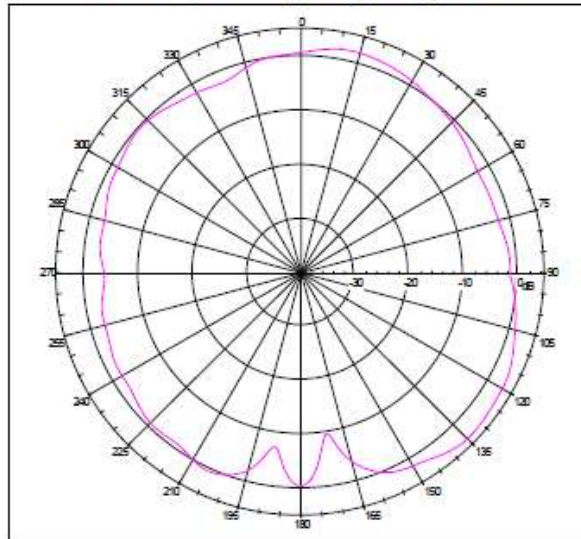

Far-field Power Distribution on Y-Z Plane(H-Plane of L3 Pol Sense)
Gain=2.76 dBi; Total Radiating Efficiency: 75.91% @2.48350 GHz

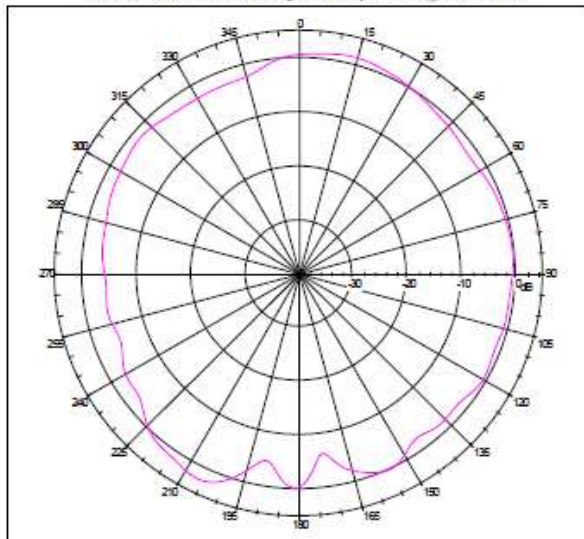

Far-field Power Distribution on X-Y Plane
Gain=2.76 dBi; Total Radiating Efficiency: 75.91% @2.48350 GHz

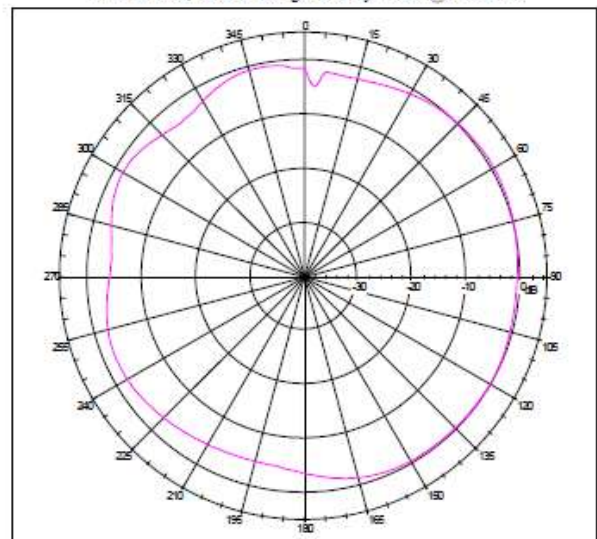

6.5 Frequency: 2.500GHz

Far-field Power Distribution on X-Z Plane(E-Plane of L3 Pol Sense)
Gain=2.34 dBi; Total Radiating Efficiency: 68.07% @2.50000 GHz

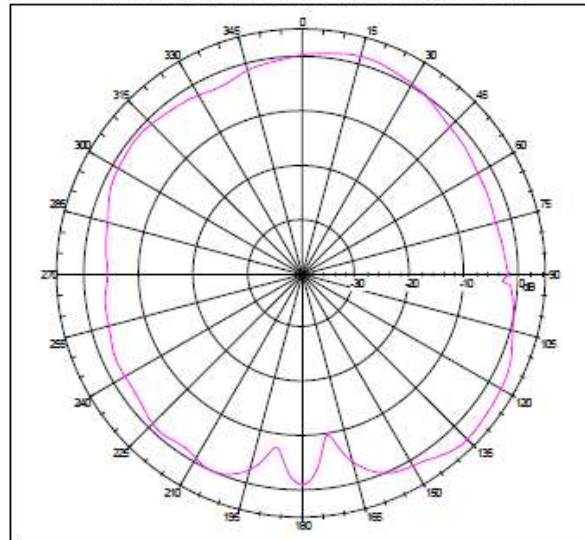

Far-field Power Distribution on Y-Z Plane(H-Plane of L3 Pol Sense)
Gain=2.34 dBi; Total Radiating Efficiency: 68.07% @2.50000 GHz

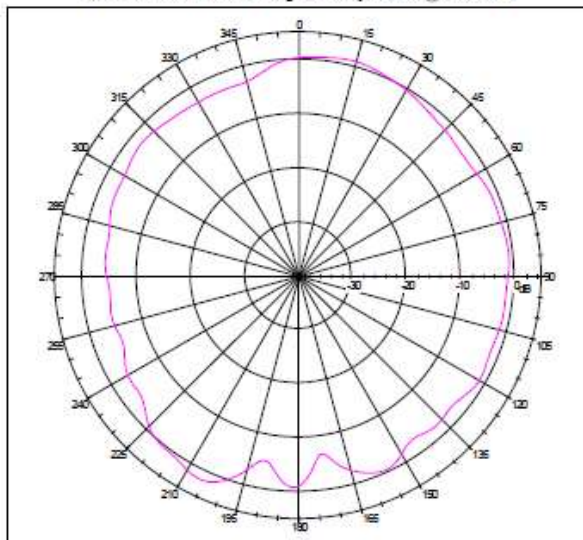



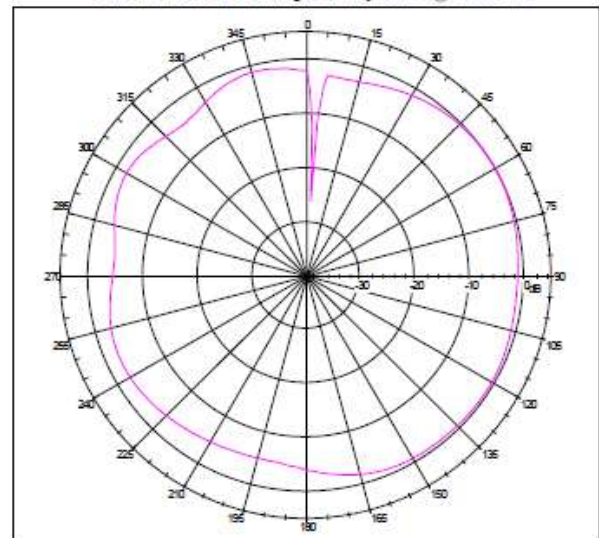

Far-field Power Distribution on X-Y Plane
Gain=2.34 dBi; Total Radiating Efficiency: 68.07% @2.50000 GHz

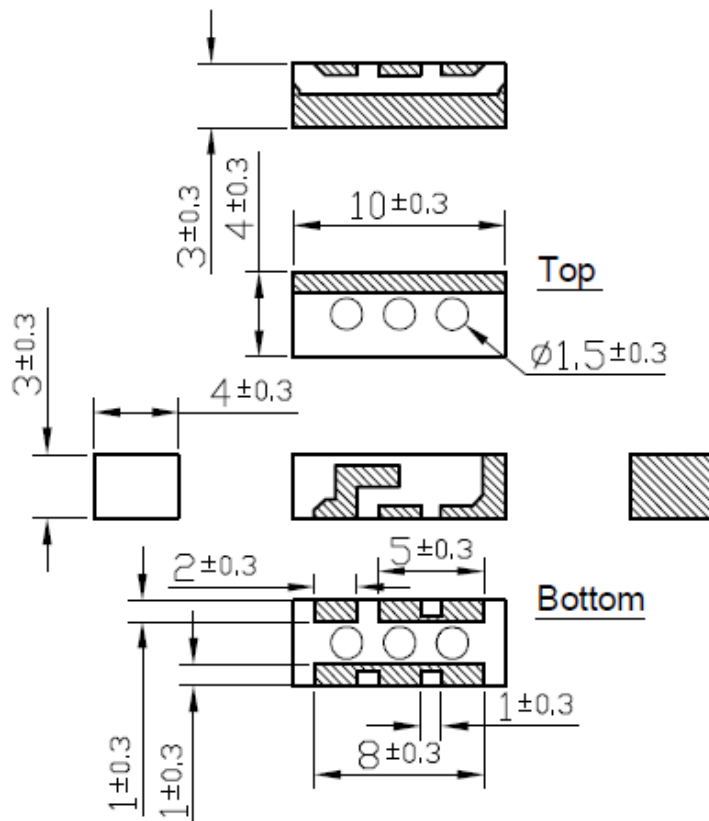

7. Mechanical Drawings (Unit:mm)



Note:

- 1. Silver 
- 2. Copper 
- 3. Solder Area 
- 4. Ground Clearance Area 

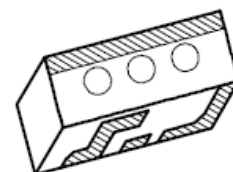

3D View

8. Recommended Footprint for Evaluation Board

Footprint 0.8t PCB

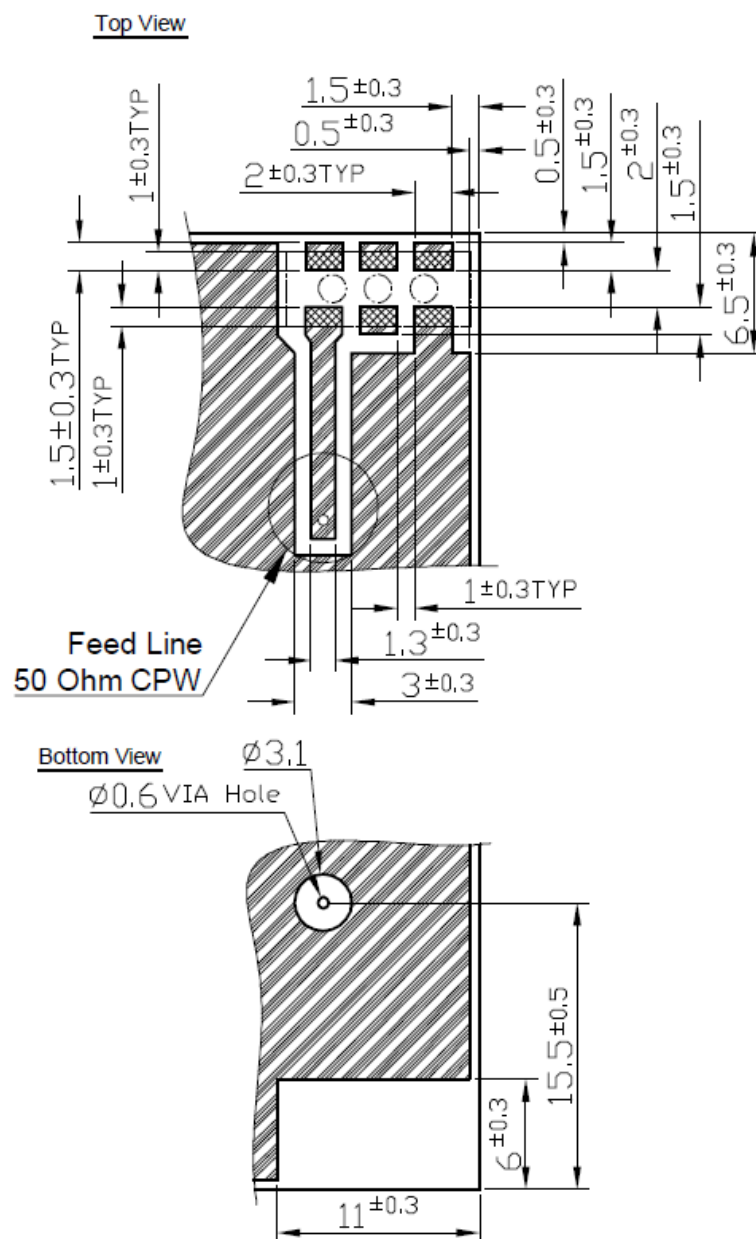

9. Packaging

1000 pcs PA.11 reel
 Dimensions - 330*30mm
 Weight - 1.1kg

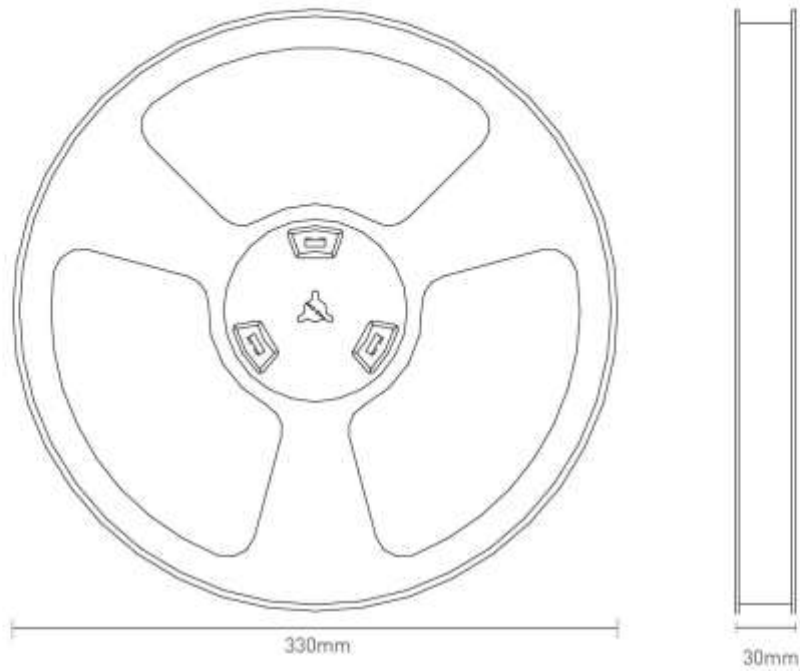

No.	Index	Spec. (mm)
1	A	4.6
2	B	10.6
3	P1	12
4	W	24
5	F	8.5
6	T	3.5
7	D	1.5

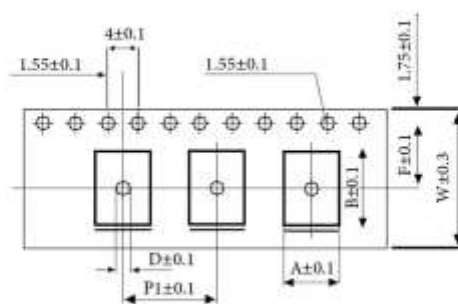

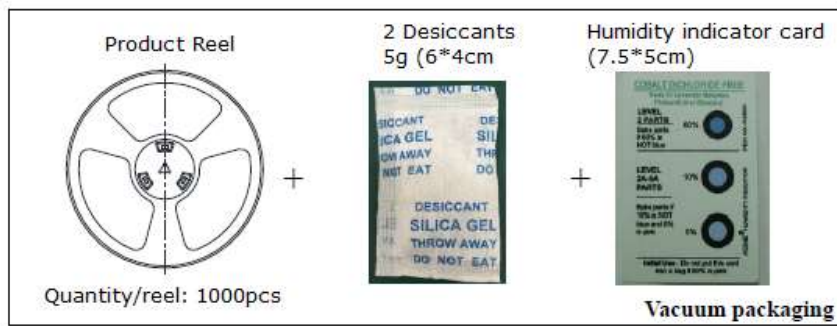

1000 pcs PA.11
1 reel in small inner box
Dimensions - 350*350*70
Weight - 1.4Kg

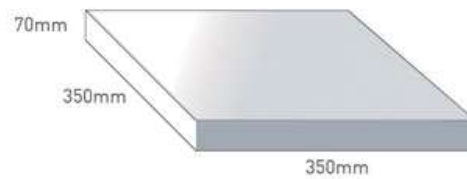

5 boxes / 5000 pcs in one carton
Carton Dimensions - 370*360*275mm
Weight - 7Kg

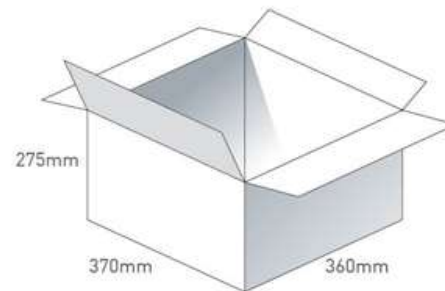

Pallet Dimensions 1110*720*1380mm
24 Cartons per Pallet
6 Cartons per layer
4 Layers

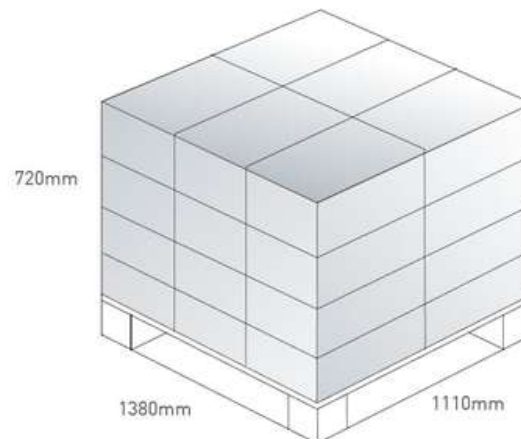

10. Recommended Reflow Temperature Profile

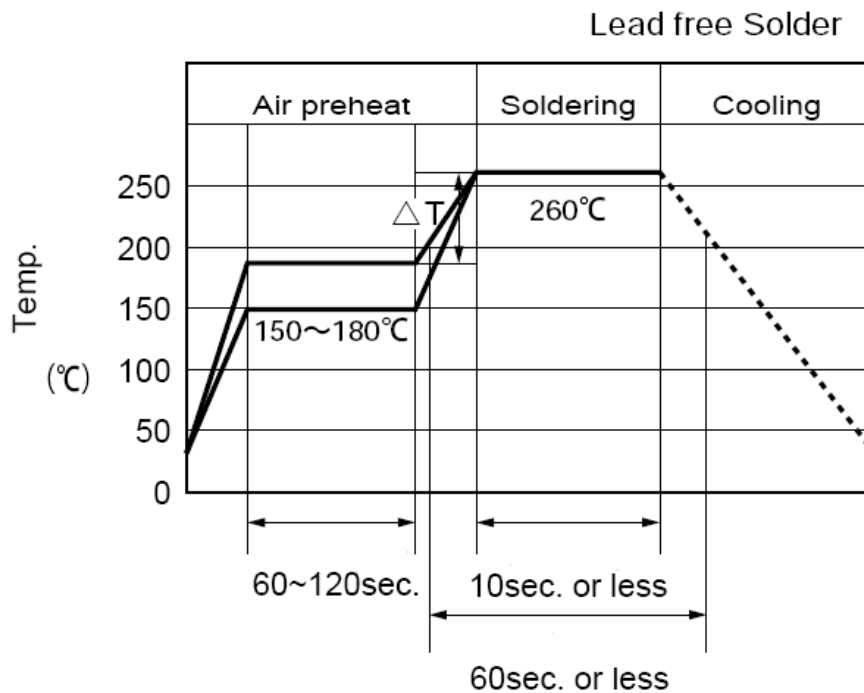

1. Time shown in the above figures is measured from the point when chip surface reaches temperature.
2. Temperature difference in high temperature part should be within 110°C.
3. After soldering, do not force cool, allow the parts to cool gradually.

General attention to soldering

- High soldering temperatures and long soldering times can cause leaching of the termination, decrease in adherence strength, and the change of characteristic may occur.
- For soldering, please refer to the soldering curves above. However, please keep exposure to temperatures exceeding 200°C to under 50 seconds.
- Please use a mild flux (containing less than 0.2wt% Cl). Also, if the flux is water soluble, be sure to wash thoroughly to remove any residue from the underside of components that could affect resistance.

Cleaning

When using ultrasonic cleaning, the board may resonate if the output power is too high. Since this vibration can cause cracking or a decrease in the adherence of the termination, we recommend that you use the conditions below.

Frequency: 40kHz
 Output Power: 20W
 Cleaning Time: 5 minutes max

Changelog for the datasheet

SPE-11-8-091 – PA.11

Revision: D (Current Version)

Date:	2020-11-10
Changes:	Updated to new format
Changes Made by:	Dan Cantwell

Previous Revisions

Revision: C

Date:	2016-01-06
Changes:	Added Packaging
Changes Made by:	Jack Conroy

Revision: B

Date:	2015-08-24
Changes:	Amended note on Gain
Changes Made by:	Aine Doyle

Revision: A (Original First Release)

Date:	2011-05-09
Notes:	
Author:	Technical Writer



TAOGLAS®

www.taoglas.com

