



Datasheet

2.4GHz High Efficiency Loop Antenna

Part No:
WLA.01

Description:

2400MHz to 2500MHz WLAN/Wi-Fi/Bluetooth

Features:

3.2*1.6*0.5mm

Low Profile

Peak gain 2.5dBi

50 Ohm Impedance

CE Certified

RoHS and REACH Compliant

1. Introduction	3
2. Specifications	4
3. Antenna Characteristics	5
4. Radiation Patterns	8
5. Mechanical Drawing	12
6. Antenna Integration Guide	13
7. Packaging	23
<hr/>	
Changelog	24

Taoglas makes no warranties based on the accuracy or completeness of the contents of this document and reserves the right to make changes to specifications and product descriptions at any time without notice. Taoglas reserves all rights to this document and the information contained herein. Reproduction, use or disclosure to third parties without express permission is strictly prohibited.



1. Introduction



The WLA.01 2.4GHz Loop antenna is a high efficiency, miniature SMD, edge mounted ceramic antenna for very small space requirements for Wi-Fi, WLAN, Zigbee, Bluetooth, and 802.11 applications. The WLA.01 uses the main PCB as its ground plane, thereby increasing Antenna Efficiency. It is tuned for different PCB sizes by simply changing the value of the matching circuit. At 3.2mm*1.6mm*0.5mm, the WLA.01 is one of the smallest antennas available worldwide. This antenna is delivered on tape and Reel.

Upon testing of any of our antennas with your device and a selection of appropriate layout, integration technique, or cable, Taoglas can make sure any of our antennas' peak gain will be below the peak gain limits. Taoglas can then issue a specification and/or report for the selected antenna in your device that will clearly show it complying with the peak gain limits, so you can be assured you are meeting regulatory requirements for that module.

For example, a module manufacturer may state that the antenna must have less than 2dBi peak gain, but you don't need to select an embedded antenna that has a peak gain of less than 2dBi in free-space. This will give you a less optimized solution. It is better to go for a slightly higher free-space peak gain of 3dBi or more if available. Once that antenna gets integrated into your device, performance will degrade below this 2dBi peak gain due to the effects of GND plane, surrounding components, and device housing. If you want to be absolutely sure, contact Taoglas and we will test. Choosing a Taoglas antenna with a higher peak gain than what is specified by the module manufacturer and enlisting our help will ensure you are getting the best performance possible without exceeding the peak gain limits.

Typical Applications Include:

- Bluetooth earphone systems
- Hand-held devices when Bluetooth/Wi-Fi functions are needed, e.g., Smart phone.
- IEEE802.11 b/g
- ZigBee
- Wireless PCMCIA cards or USB dongle

The WLA.01 is designed to mount at the center of the edge of an evaluation board of 80 x 40mm. The antenna performance was measured with the WLA.01 mounted on the evaluation board with SMA(F) connector.

2. Specifications

Electrical	
Centre Frequency	2400-2500MHz
VSWR	2 Max
Radiation Pattern	Omnidirectional
Input Power	5W
Bandwidth	100MHz min.
Peak Gain	1dBi typ.
Efficiency	68% typ.
Impedance	50 Ω
Mechanical	
Dimensions	3.2*1.6*0.5mm
Material	Ceramic
Environmental	
Operating Temperature	-40°C~+85°C
Storage Temperature	-40°C~+105°C
Temperature Coefficient (tf)	0 \pm 20 ppm @-20°C to +80°C
Recommended Reel Storage Condition	5°C to 40°C Relative Humidity 20% to 70%
Moisture Sensitivity Level	3 (168 Hours)

3. Antenna Characteristics

3.1 Return Loss

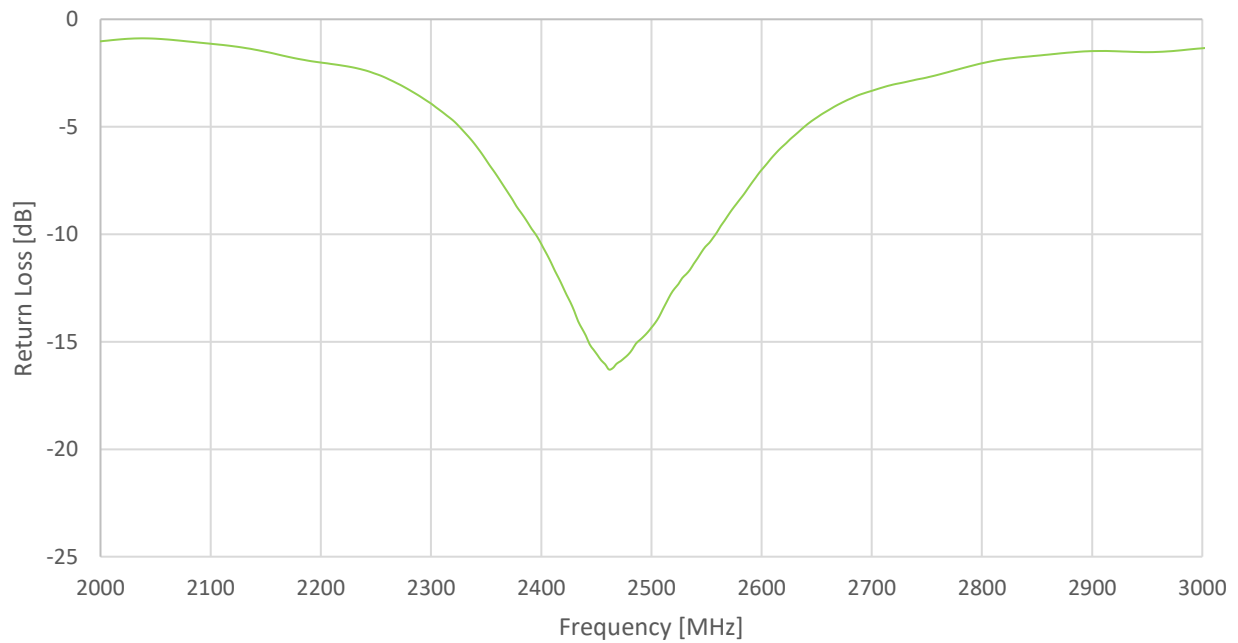

3.2 VSWR

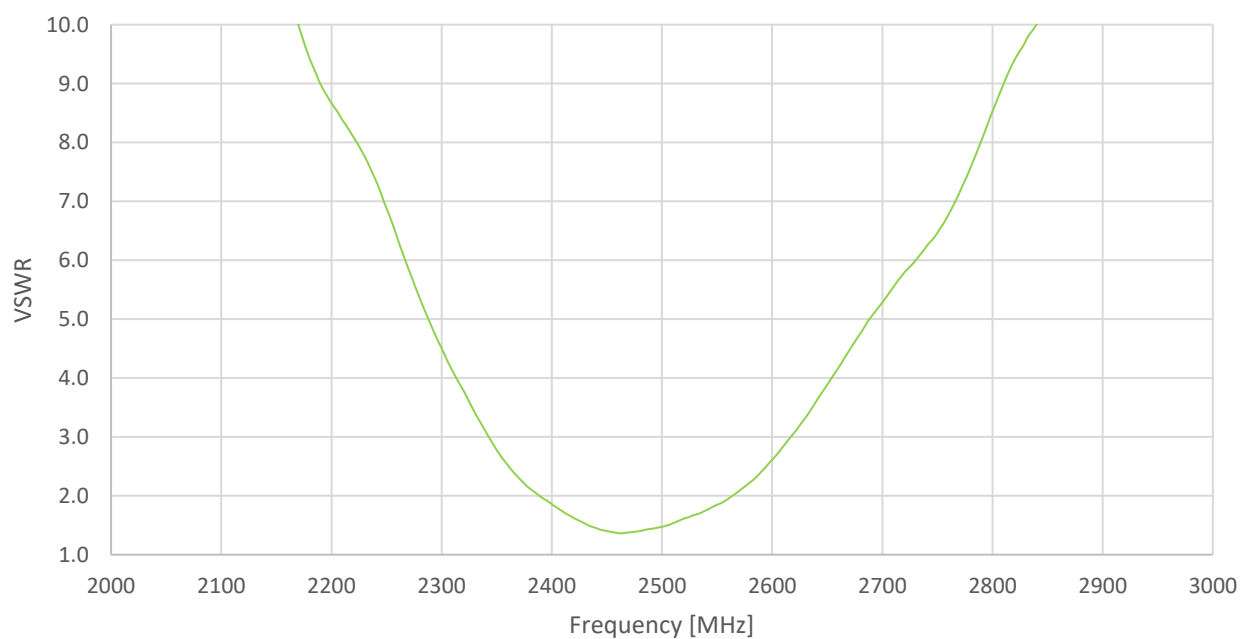

3.3 Efficiency

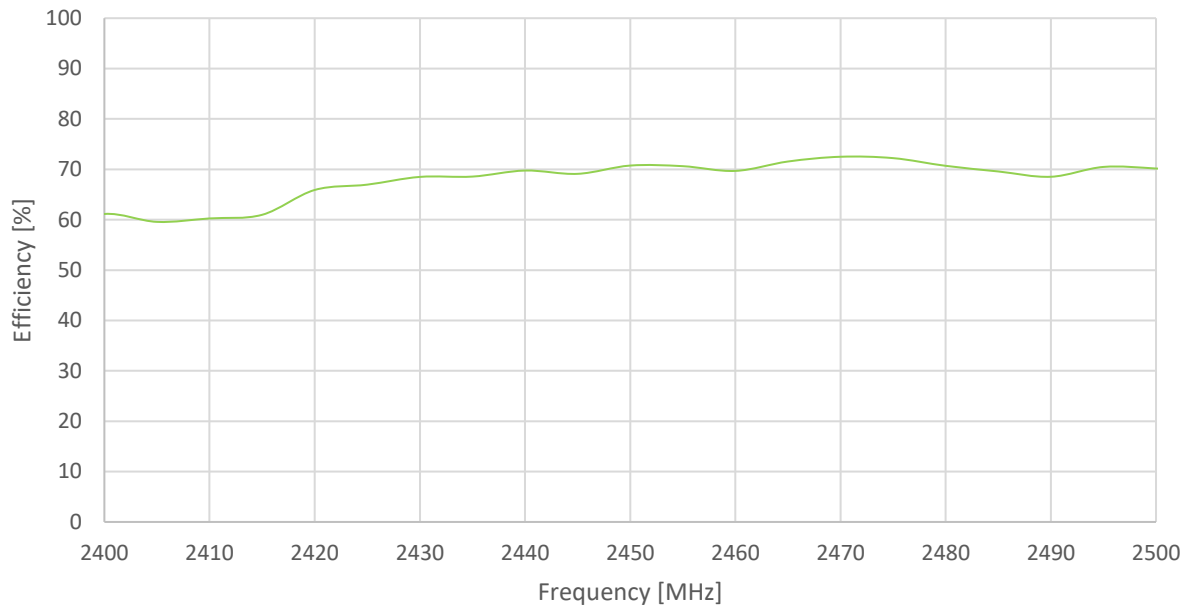

3.4 Peak Gain

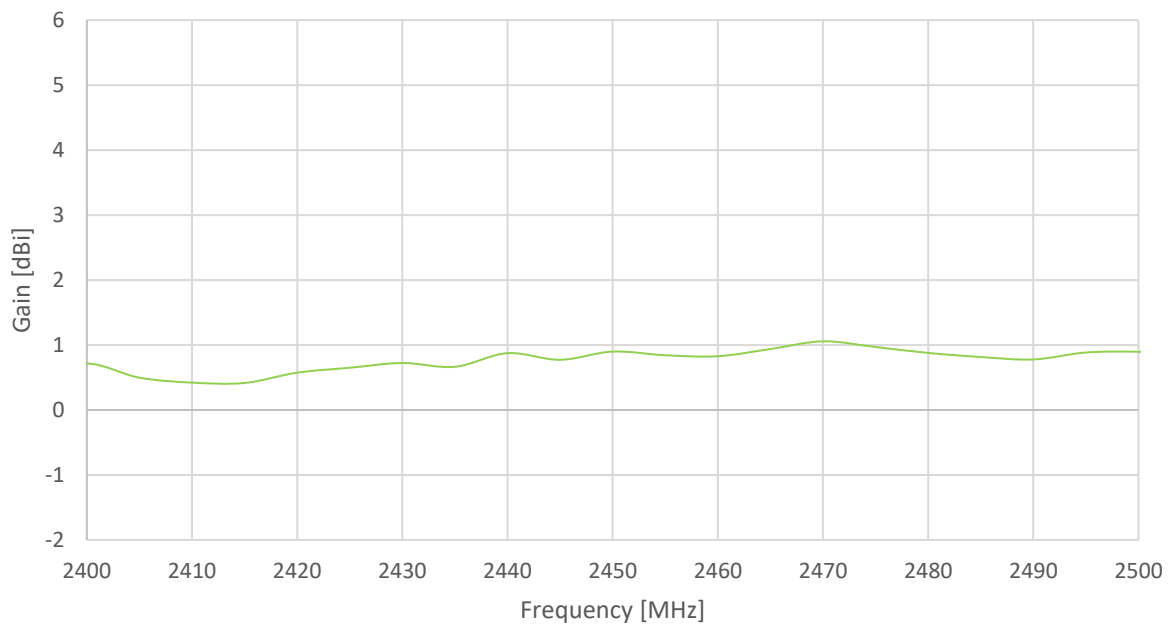

3.5 Average Gain

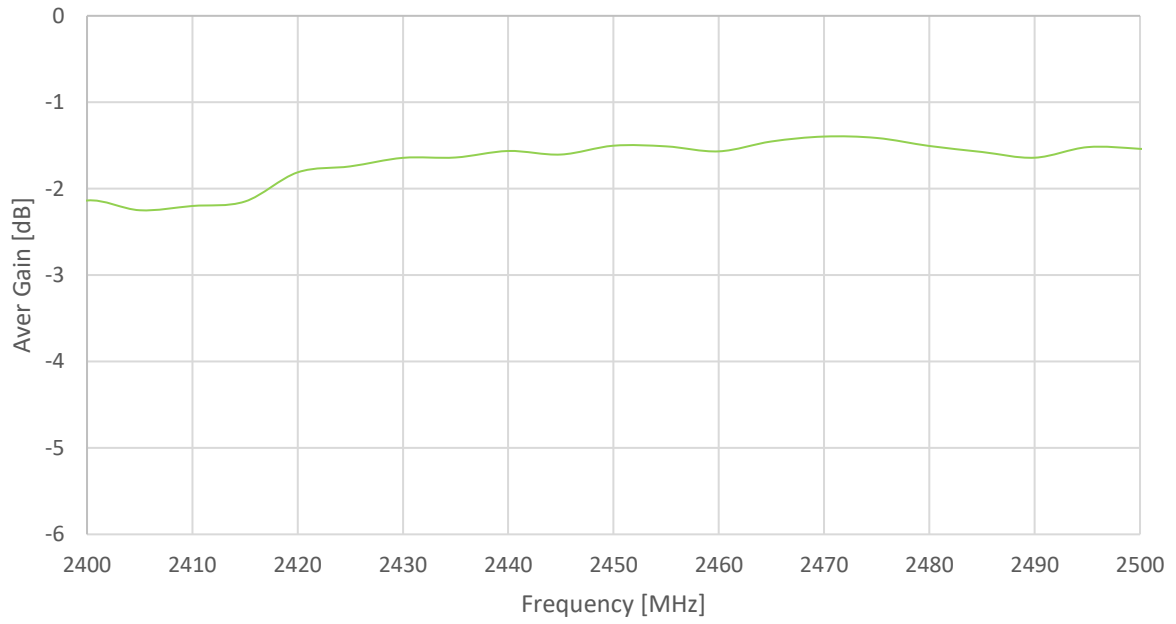

4. Radiation Patterns

4.1 Test Setup

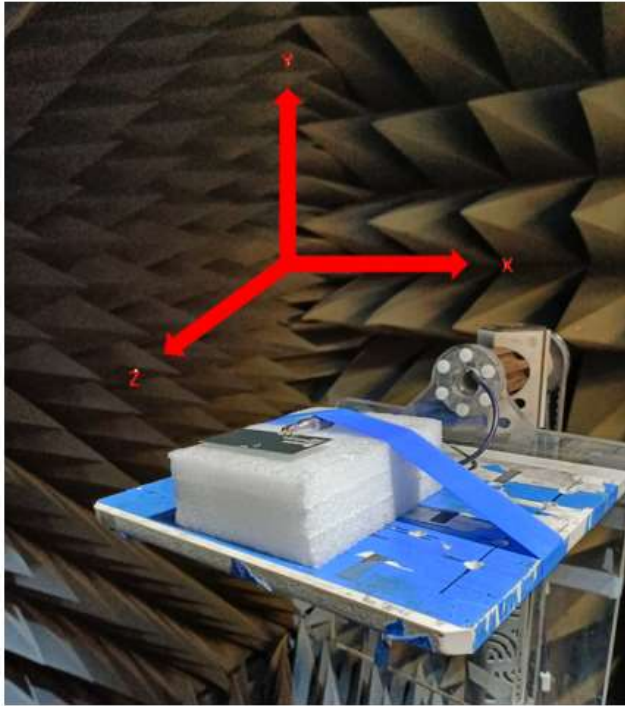

Chamber Setup

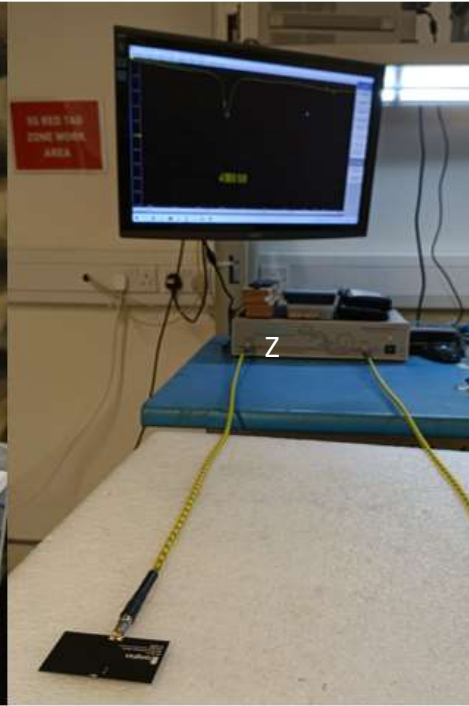

VNA Setup

4.2 2400MHz 3D and 2D Radiation Patterns

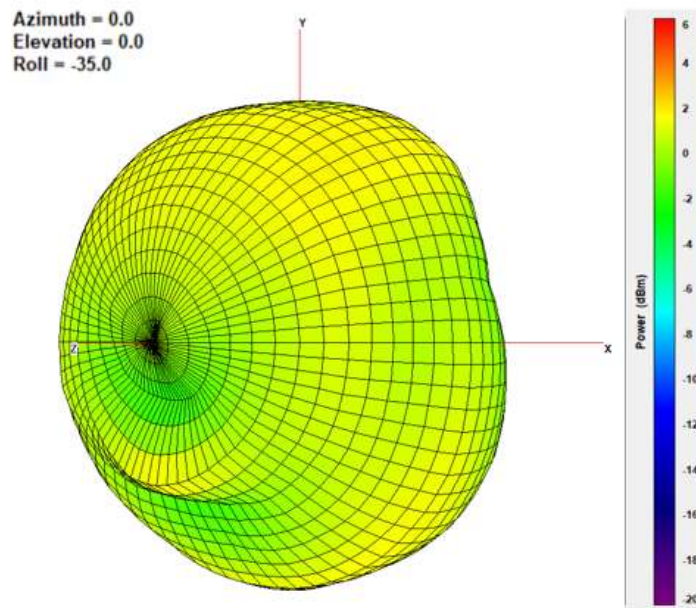

XY Plane

XZ Plane

YZ Plane

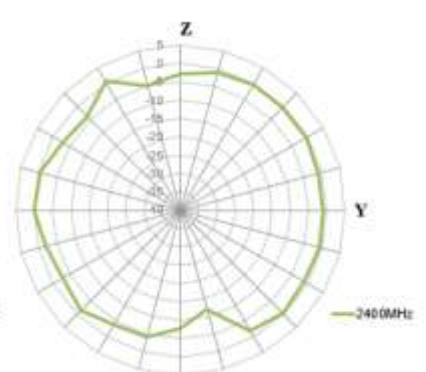
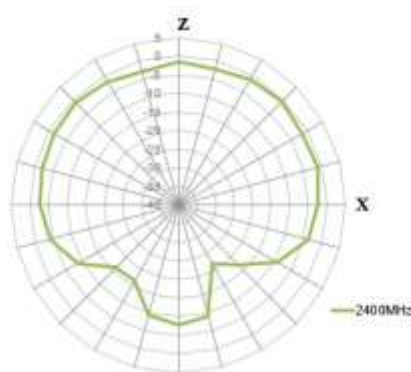
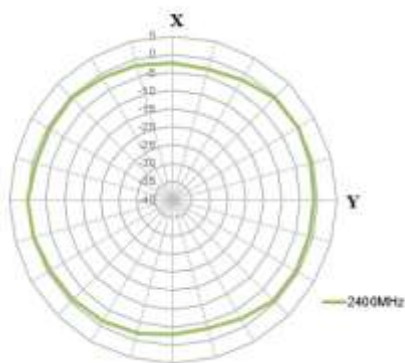

2450MHz

Azimuth = 0.0
Elevation = 0.0
Roll = -35.0

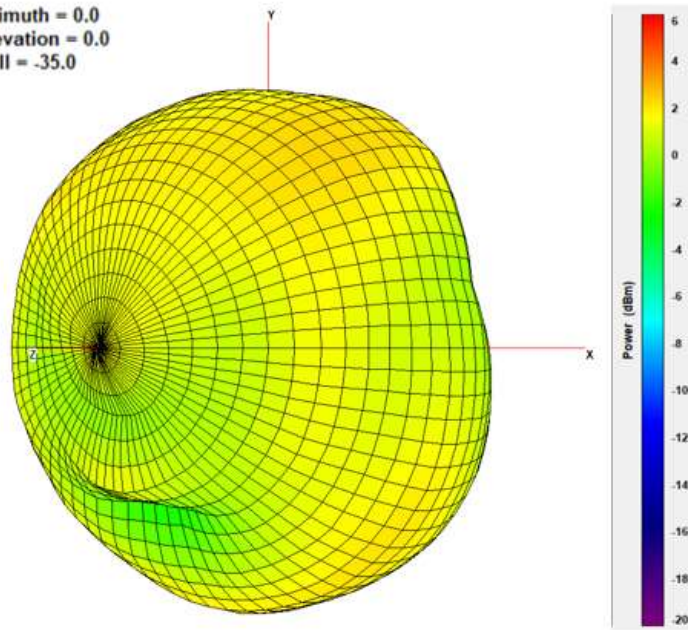

XY Plane

XZ Plane

YZ Plane

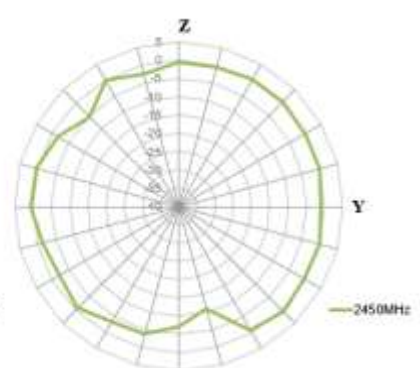
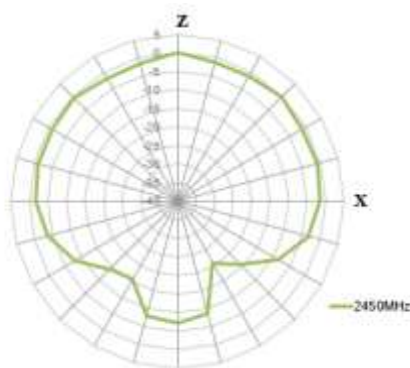
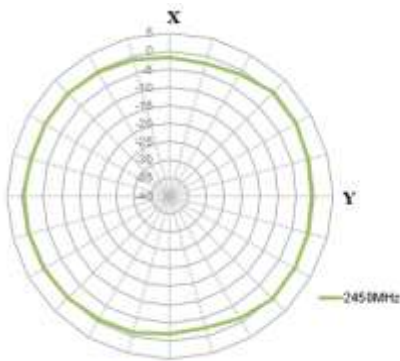

2500MHz

Azimuth = 0.0
Elevation = 0.0
Roll = -35.0

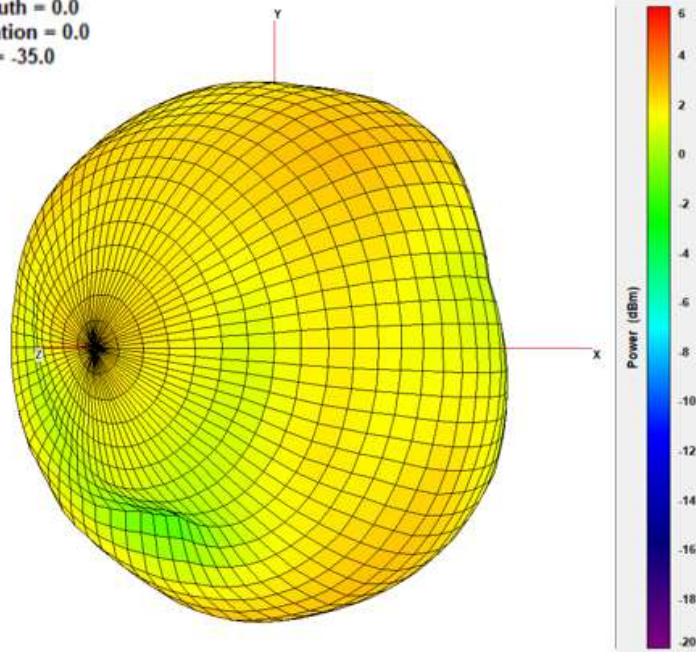

XY Plane

XZ Plane

YZ Plane

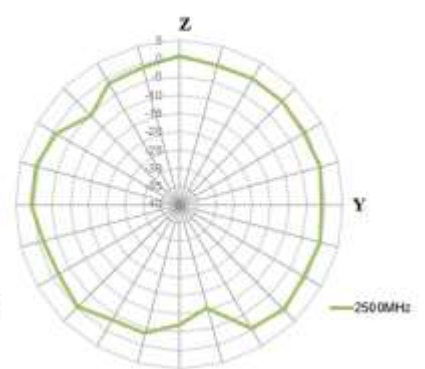
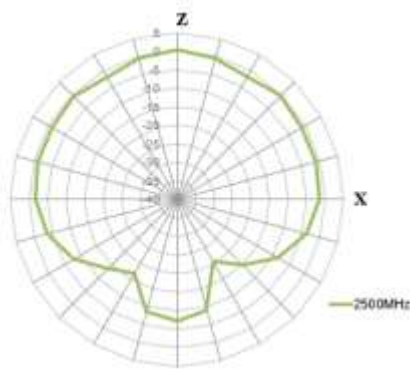
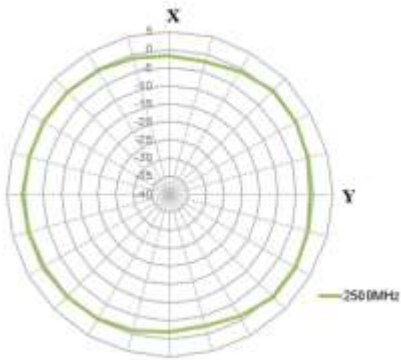

5. Mechanical Drawing (Units: mm)

NOTES:  - AG PLATING

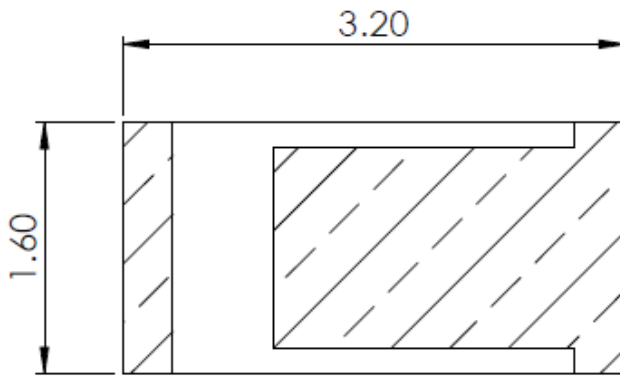

TOP VIEW

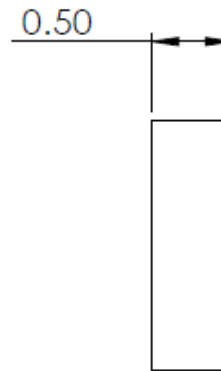

SIDE VIEW



FRONT VIEW

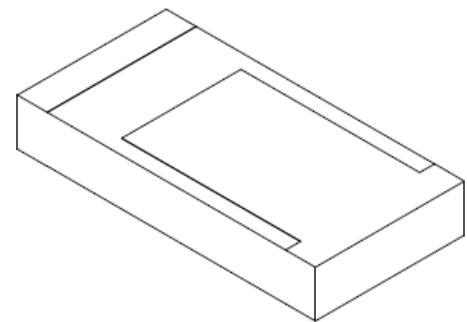

ISOMETRIC VIEW

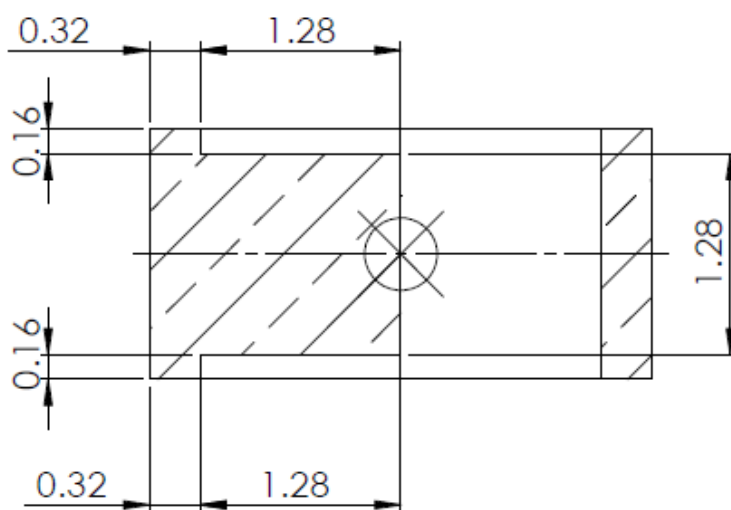

BOTTOM VIEW

6. Antenna Intergration Guide

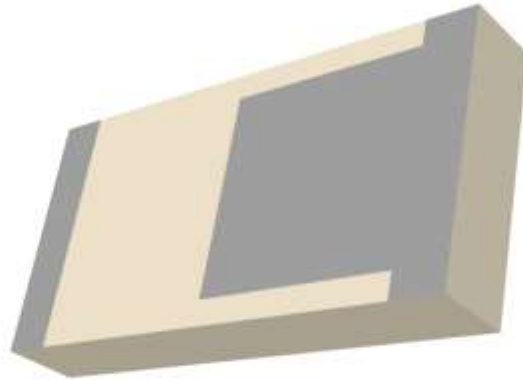

6.1 Schematic Symbol and Pin Definition

The circuit symbol for the antenna is shown below. The antenna has 3 pins with only three pins as functional.

Pin	Description
1	RF Feed
2	Ground
3	FTE

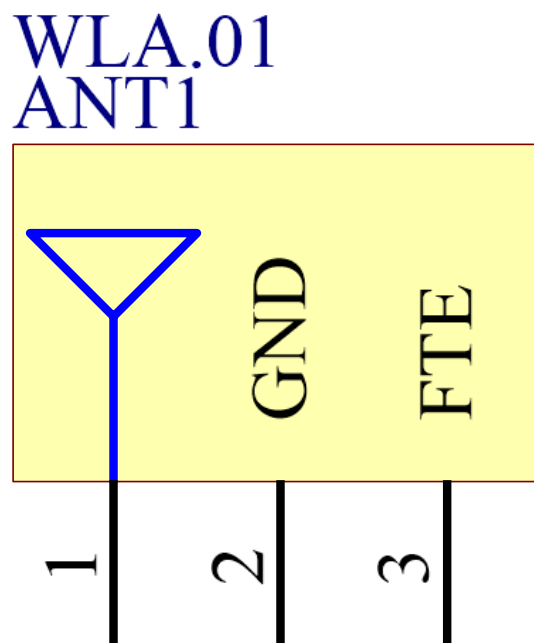

Please note you can download the design files, 3D model, 2D drawings and CST simulation files from the website here:

<https://www.taoglas.com/product/wla-01-2-42-5ghz-ceramic-loop-antenna-3-21-60-5mm-linear-polarized/>

6.2 Antenna Integration

Whatever the size of the PCB, the antenna should ideally be placed on the PCB's longest side, to take advantage of the ground plane. Optimized matching components can be placed as shown.

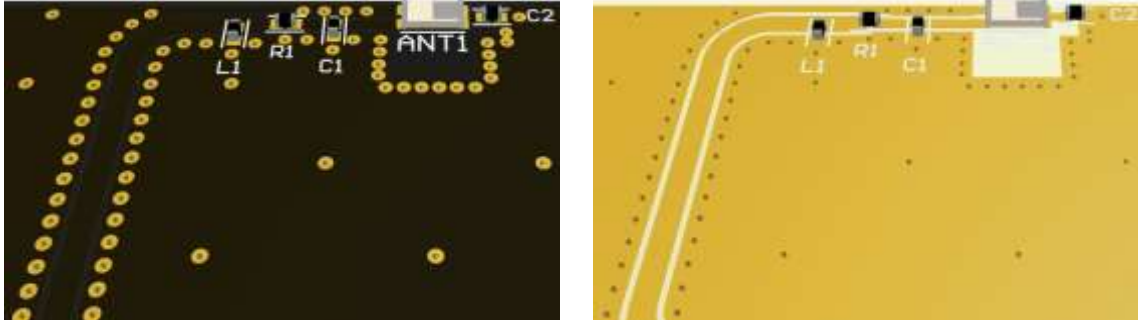

6.3 PCB Layout

The footprint and clearance on the PCB must meet the antenna specification. An example of the PCB layout shows the antenna footprint with clearance. Note the placement of the component C2. C2 is connected to Pin 3 of the antenna and helps with fine-tuning of the antenna. Further, note the placement of the additional components L1, R1, C1. These form a pi-matching network to help with matching the antenna in its final environment.

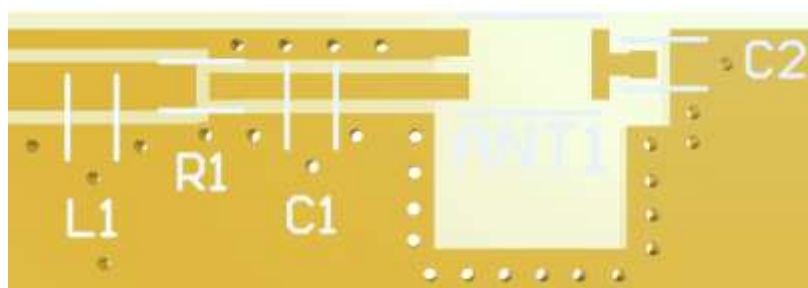

Topside



Bottom Side

6.4 PCB Keep Out

Below shows the antenna footprint and clearance through ALL layers on the PCB. Only the antenna pads and connections to feed and GND are present within this clearance area (marked RED). The clearance area extends to 5mm in length & 5.4mm in width. This clearance area includes the bottom side and ALL internal layers on the PCB.

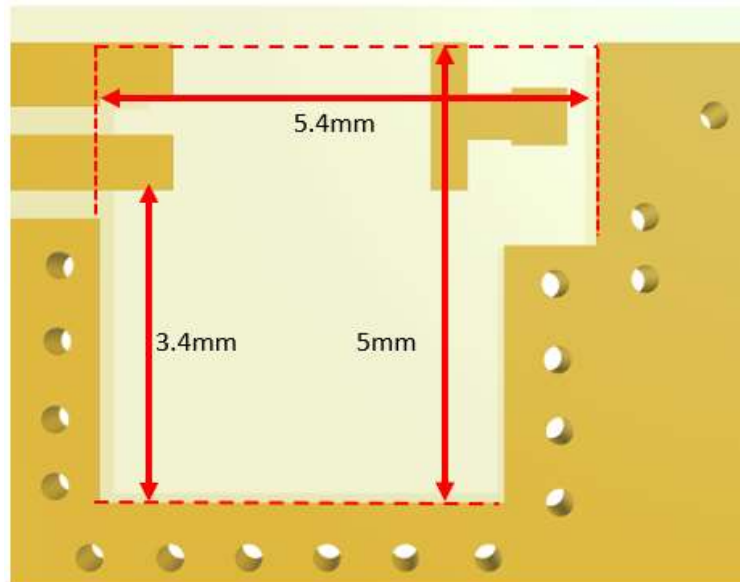

Topside

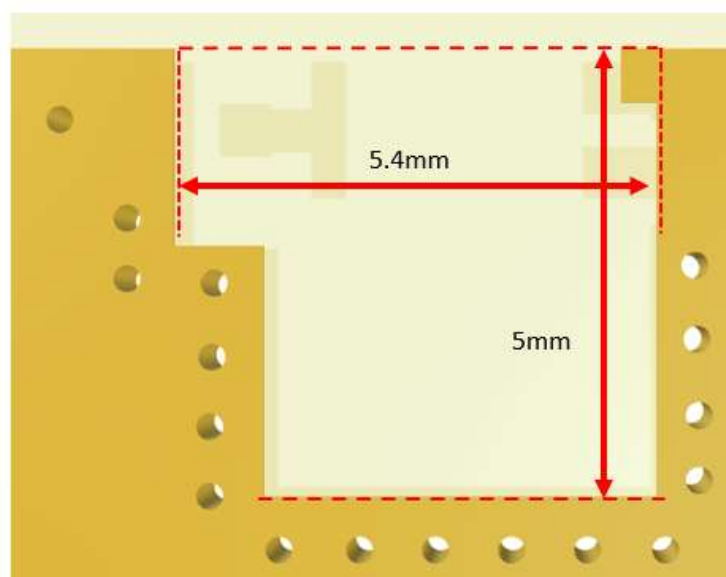

Bottom Side

6.5 Evaluation Board

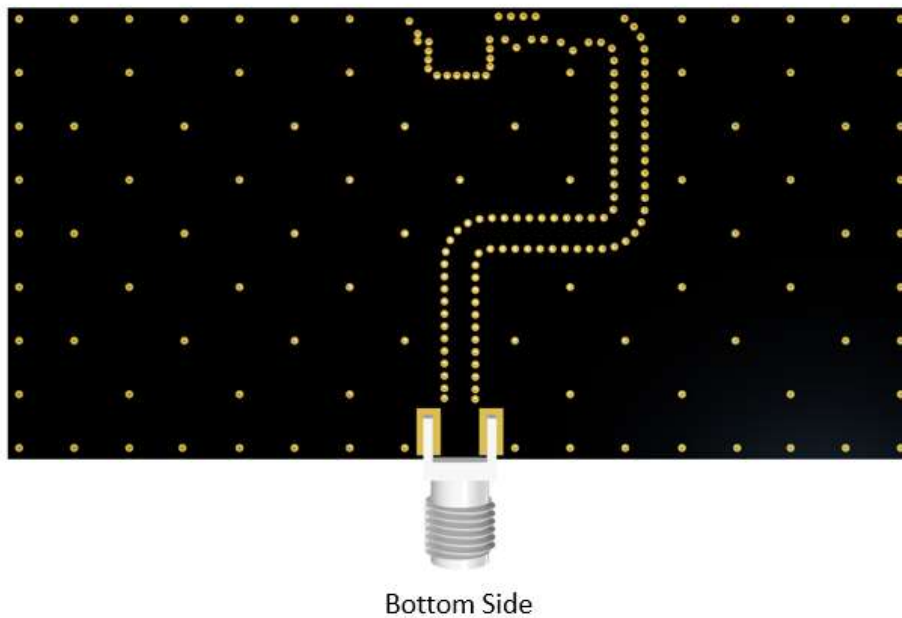
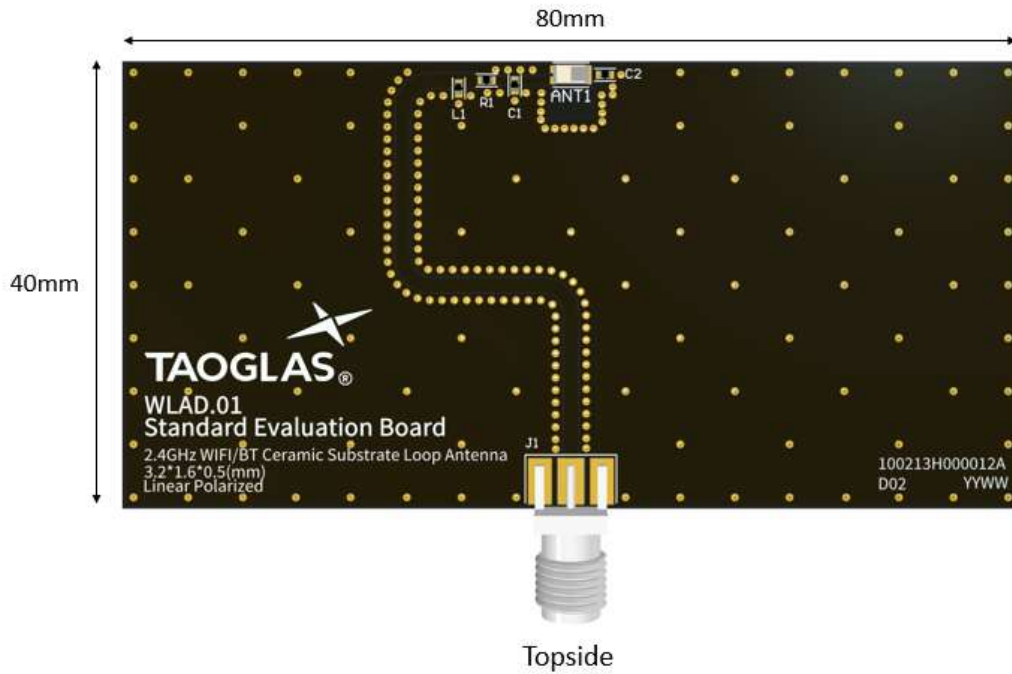

6.6 Evaluation Board Ground Plane Length

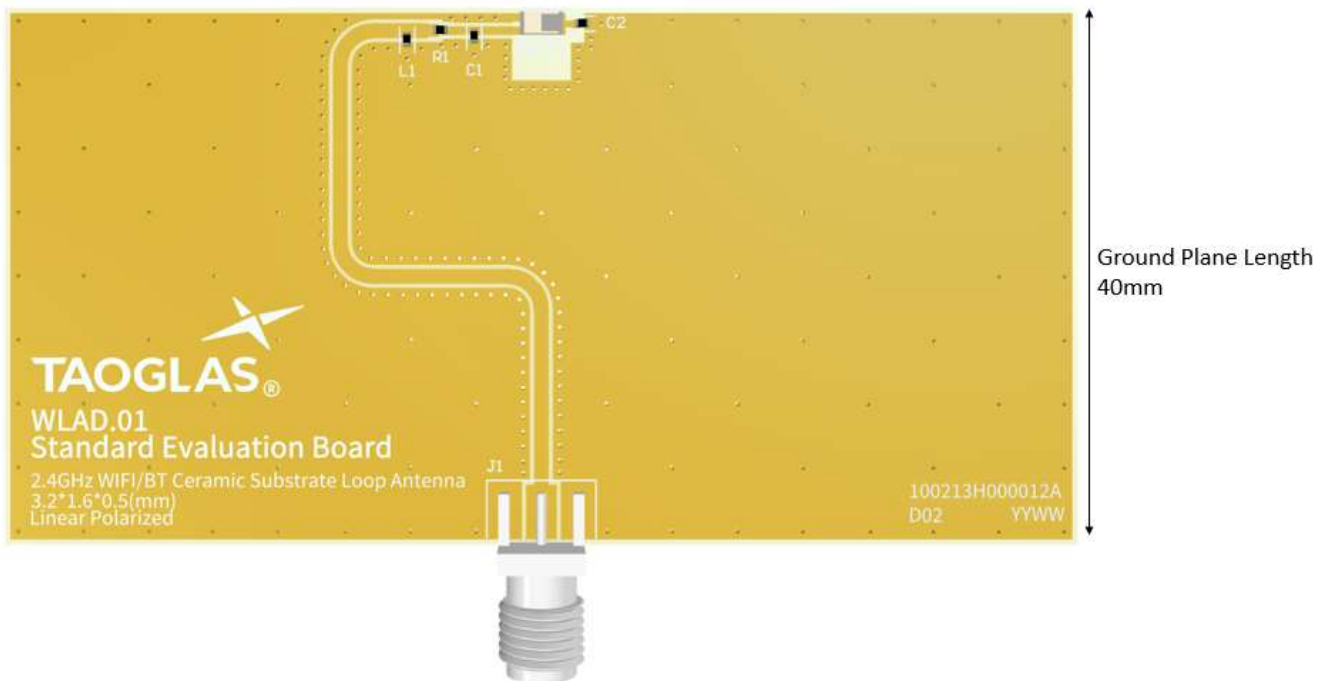

6.7 Evaluation Board Matching Circuit

A matching component (C1) in parallel with the WLA.01 is required for the antenna to have optimal performance on the evaluation board, located outside of the ground plane in the space specified in the above images. Additional matching components may be necessary for your device, so we recommend incorporating extra component footprints, forming a “pi” network, between the cellular module and the edge of the ground plane.

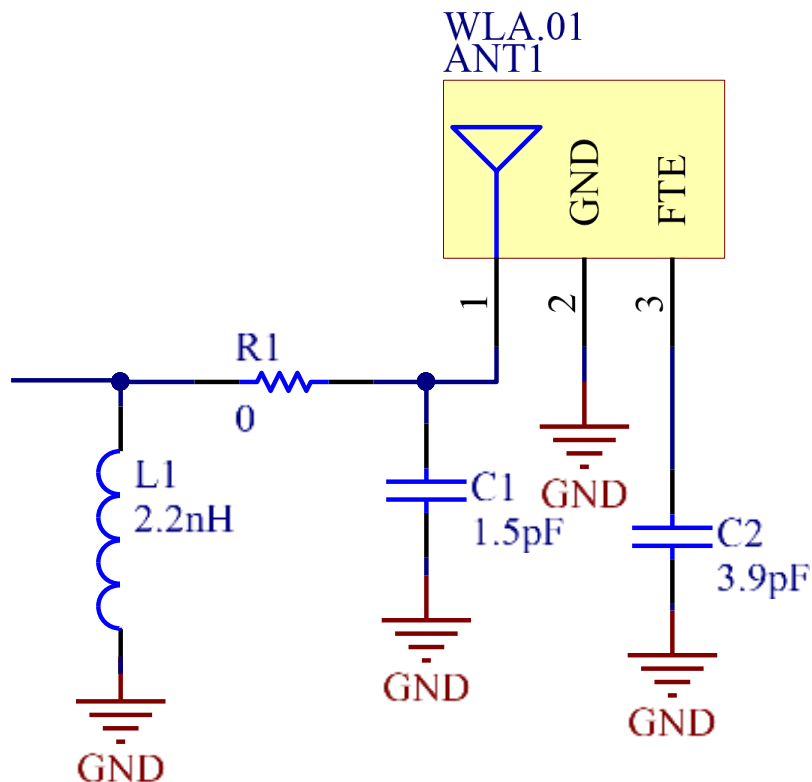

Designator	Type	Value	Manufacturer	Manufacturer Part Number
L1	Inductor	2.2nH	TDK	MLK1005S2N2ST000
R1	Resistor	0 Ohms	Yageo	RC0402FR-070RL
C1	Capacitor	1.5pF	Murata	GRM1555C1H1R5CA01D
C2	Capacitor	3.9pF	Murata	GRM1555C1H3R9CA01D

6.8 PCB Footprint Information

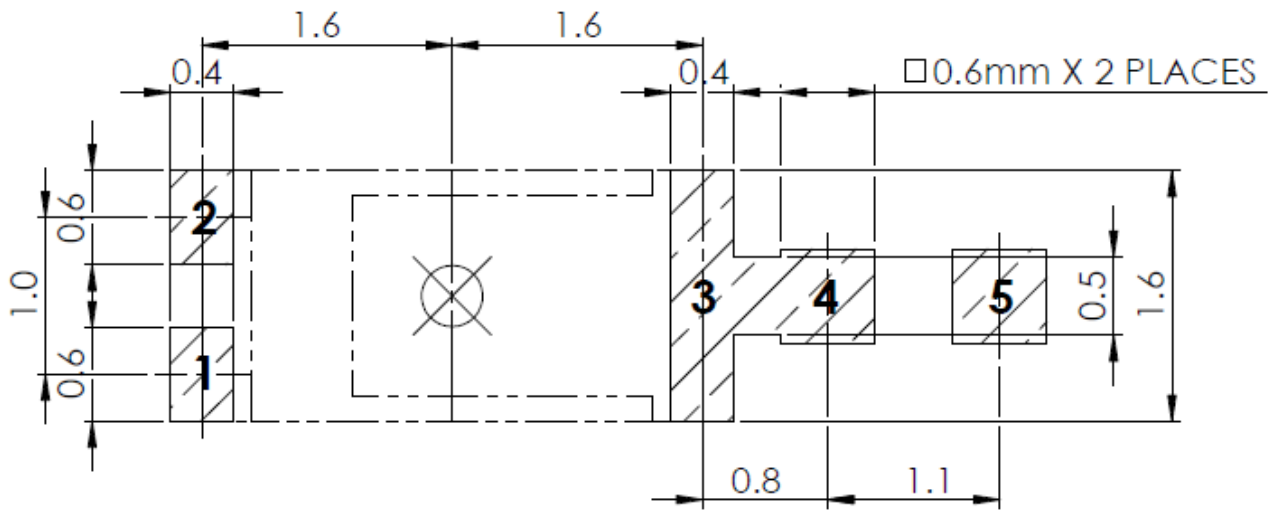

PCB FOOTPRINT

PIN:	DESCRIPTION:
1	Feed (50 ohm)
2	Ground
3	FTE
4,5	Fine Tuning Components

6.9 Copper Keepout Area

- NOTES:
-  - COPPER AREA
 -  - COPPER KEEPOUT AREA
 -  - PASTE AREA

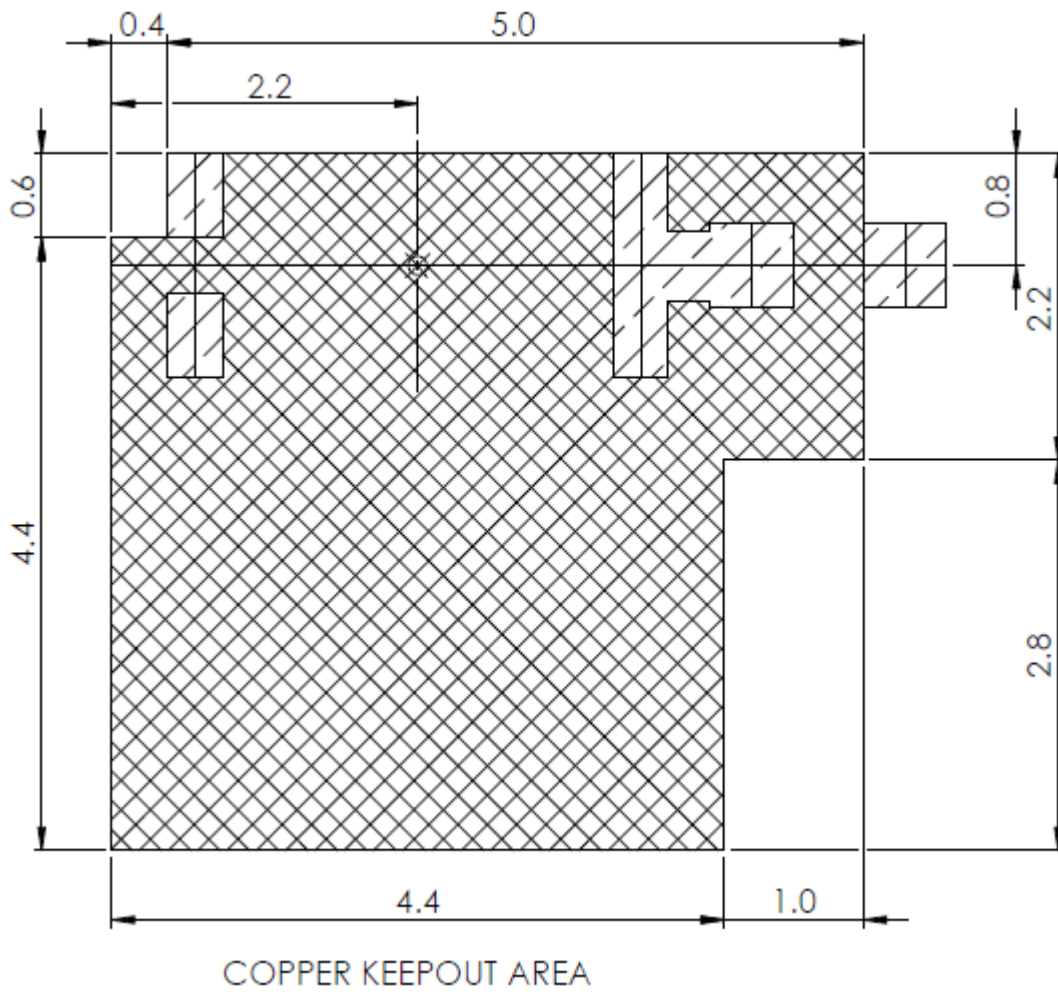

6.10 Top Solder Paste

- NOTES:
-  - COPPER AREA
 -  - COPPER KEEPOUT AREA
 -  - PASTE AREA

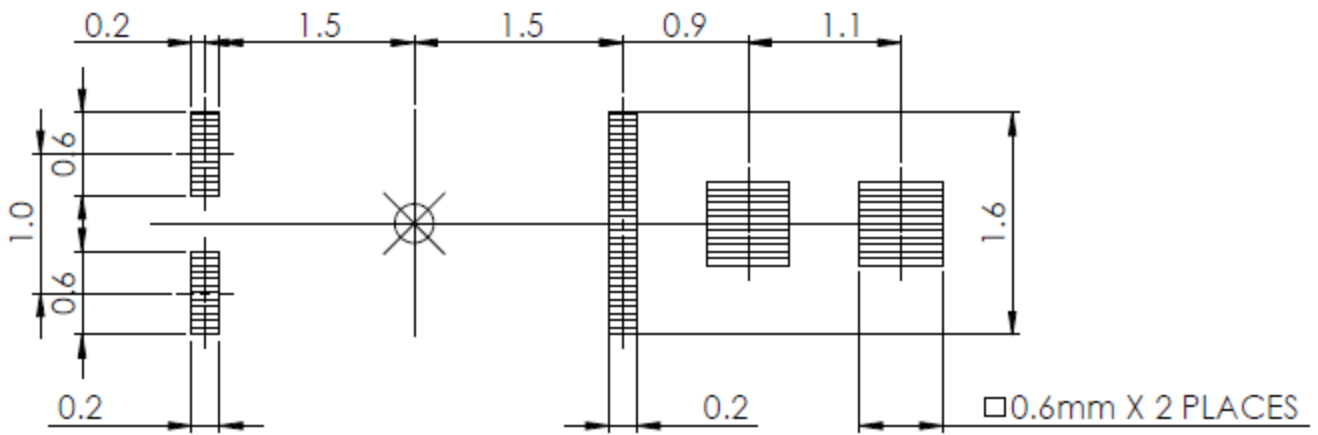

TOP SOLDER PASTE

7. Packaging

6000pcs WLA.01 per Tape and Reel
 Dimensions: Ø330*60mm
 Weight: 3.23Kg

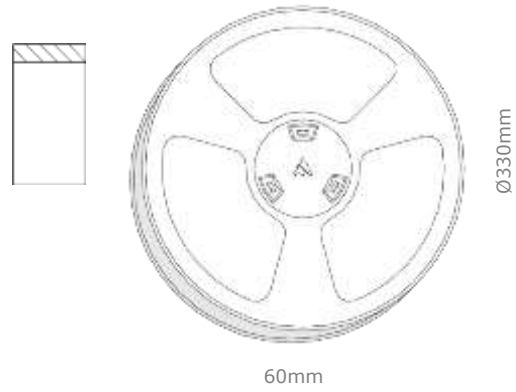

6000pcs WLA.01 per Carton
 Dimensions: 340*340*90mm
 Weight: 3.5Kg



Changelog for the datasheet

SPE-11-8-146 – WLA.01

Revision: O (Current Version)

Date:	2022-01-14
Changes:	Updated Antenna Integration Guide
Changes Made by:	Gary West

Previous Revisions

Revision: N

Date:	2021-10-18
Changes:	Full datasheet template update, Retested antenna and populated graphs, Added MSL to spec table & Added antenna integration guide.
Changes Made by:	Gary West

Revision: I

Date:	2016-09-13
Changes:	
Changes Made by:	Technical Writer

Revision: M

Date:	2019-08-27
Changes:	Updated drawings, packaging and overall typography
Changes Made by:	Russell Meyler

Revision: H

Date:	2015-08-21
Changes:	Added note on gain
Changes Made by:	Aine Doyle

Revision: L

Date:	2018-09-10
Changes:	
Changes Made by:	Jack Conroy

Revision: G

Date:	2014-07-23
Changes:	Updated Frequency Page 3
Changes Made by:	Aine Doyle

Revision: K

Date:	2016-12-20
Changes:	Updated drawing as per PCN-80
Changes Made by:	Andy Mahoney

Revision: F

Date:	2014-07-14
Changes:	Added in Solder details
Changes Made by:	Aine Doyle

Revision: J

Date:	2016-09-28
Changes:	Amended drawing to make clearer that only certain pads should be connected to GND
Changes Made by:	Jack Conroy

Revision: E

Date:	2014-04-23
Changes:	Amended 6.2 Mtaching component table
Changes Made by:	Aine Doyle

Previous Revisions (Continued)

Revision: D	
Date:	2014-01-31
Changes:	Amended drawings of EVB
Changes Made by:	Aine Doyle

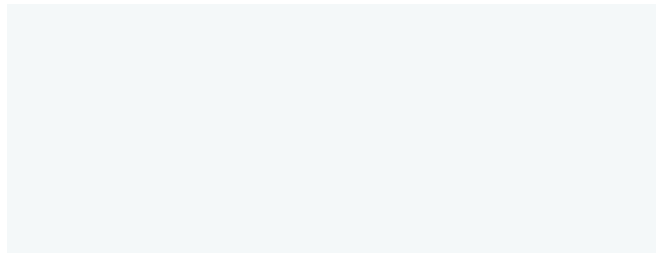

Revision: C	
Date:	2012-06-27
Changes:	
Changes Made by:	Technical Writer

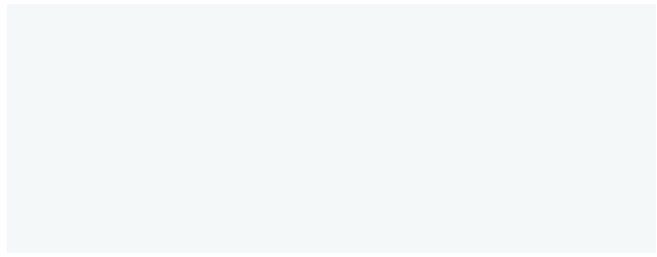

Revision: B	
Date:	2012-12-01
Changes:	
Changes Made by:	Technical Writer

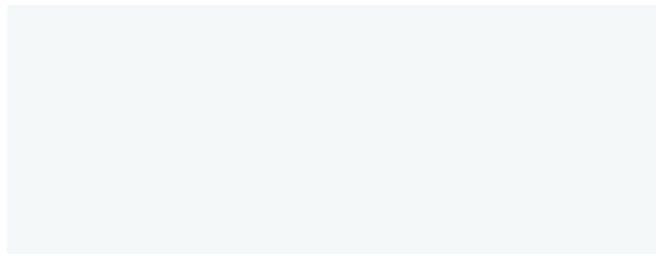

Revision: A (Original First Release)	
Date:	2011-11-30
Notes:	First Release
Author:	Technical Writer

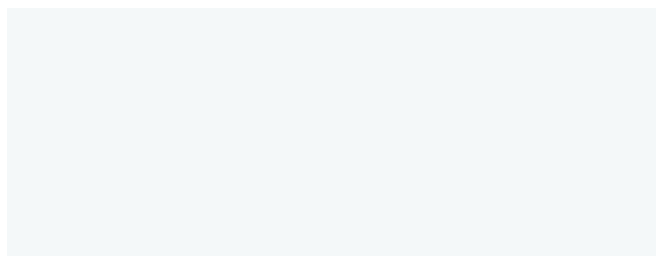
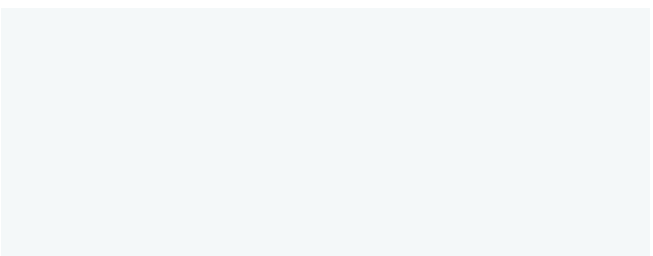
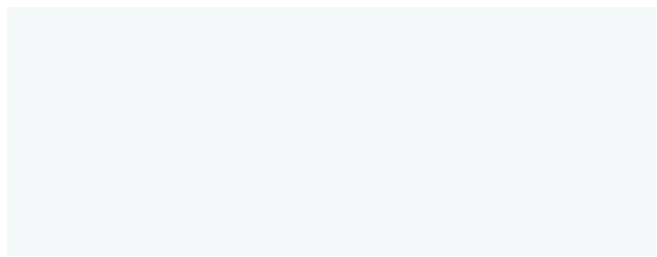
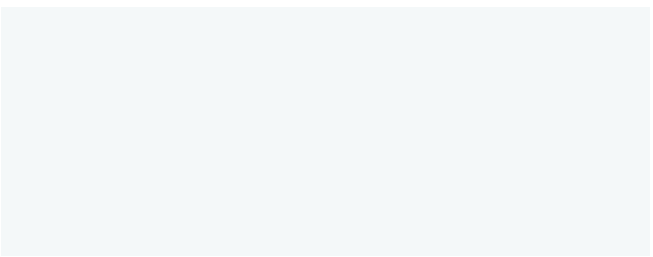
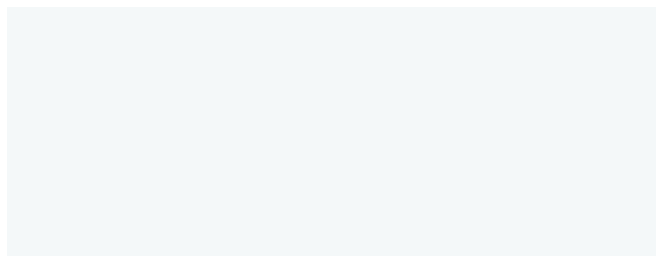



TAOGLAS®

www.taoglas.com

