

## PCN – Process Change Notification

Change:	PCB.SMAFST.2H.A.HT
Date:	2017/05/16
Author	Bonnie Chen

### Affected Products

Model#	Part Number	Changes
SMA Straight Panel Mount, Jack, Gold, 50Ω, 2 Mounting Holes, Solder Termination Coaxial	PCB.SMAFST.2H.A.HT	1. Amend Package Rule.

### Type of Change

- Hardware Modification  
 Production Process Advance  
 Others –Amend Package Rule
- 

### Description of Change

1. Amend Package Rule.

### Schedule

2017, May, Taoglas will provide new package rule into production.

### Forecast Estimated Transition Date

May/2017

## Illustration of Change

### Old Packaging

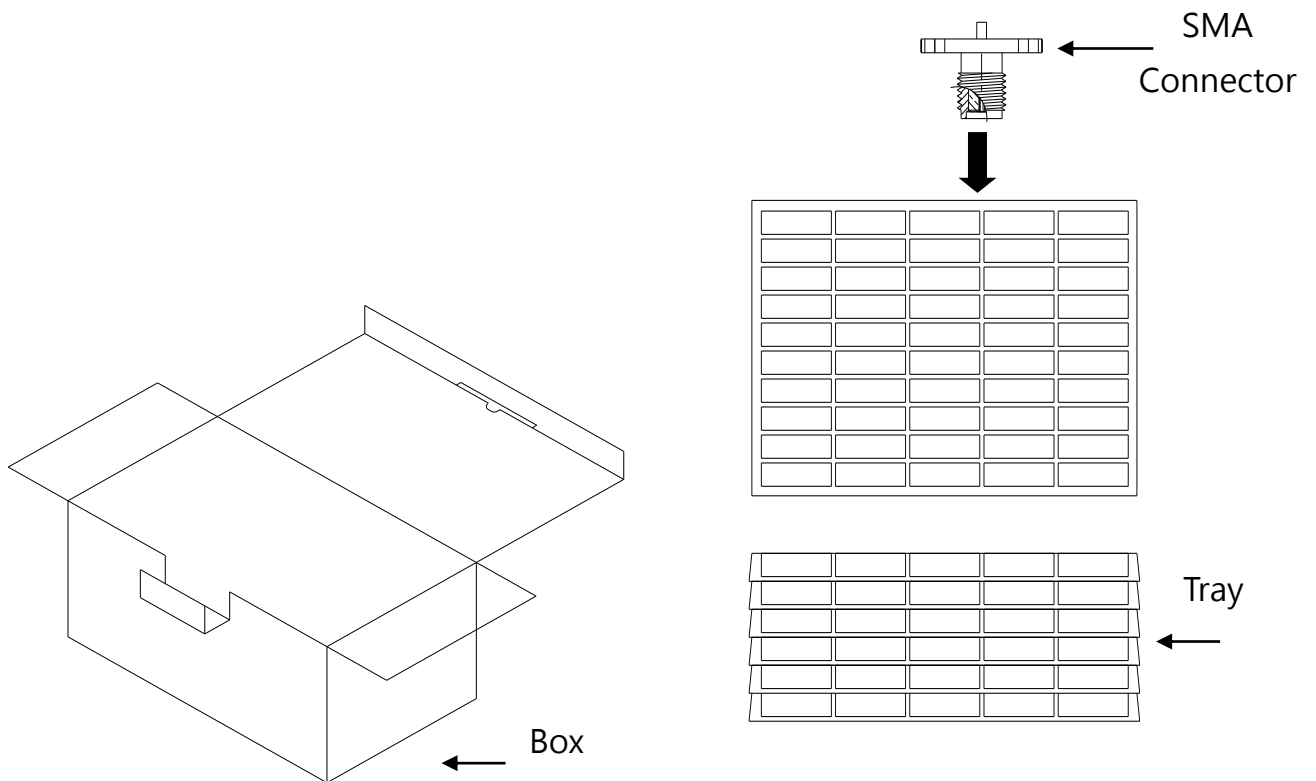

**New Packaging**

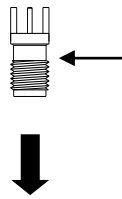

SMA Connector

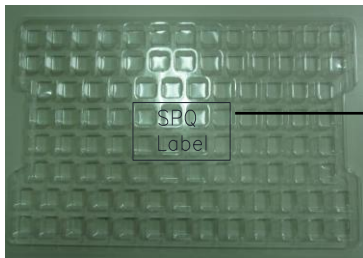

- ① P/N: Taoglas的品號
- ② SPQ QTY: SPQ的數量
- ③ Unit: 每一數量的單位

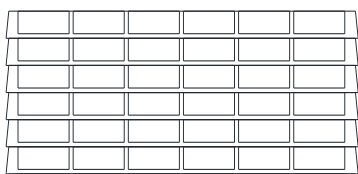

500pcs/Tray \* 6 (Vacuum)  
Tray dimension: 268\*180mm

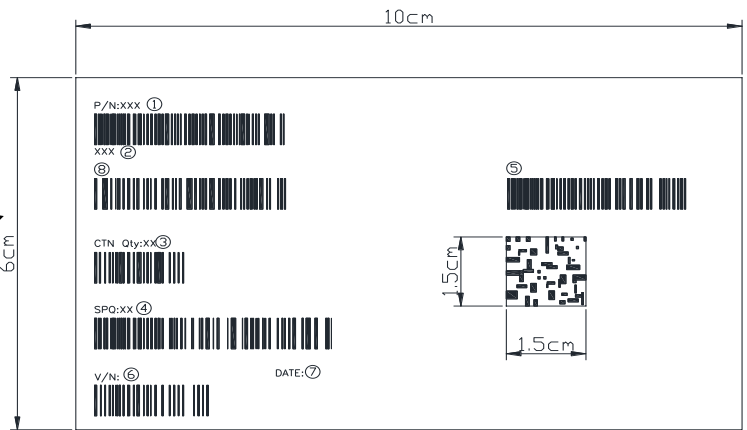
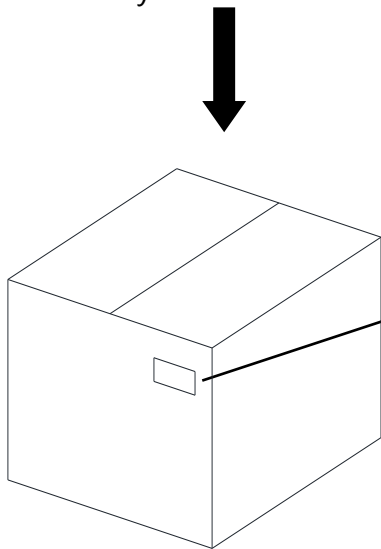

- 1. P/N: Taoglas的品號
- 2. Description: Taoglas的品名
- 3. CTN QTY: 外箱數量
- 4. SPQ QTY: SPQ數量
- 5. Purchase No.: Taoglas採購單號
- 6. V/N: 廠商品號
- 7. 預定銷貨日, 格式為DATE:yyyy/mm/dd
- 8. Batch No.: Taoglas的批號, 請廠商依下列批號原則建立每批進廠批號, 廠商碼將另行通知。

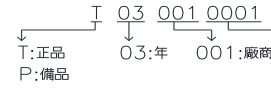

3000PCS / Carton  
(375\*285\*155mm)